

# ***Kommander-KA02 I***

Aluminum 200W compact amplifier and processing solution

USER GUIDE



•20230206•



**K-ARRAY**  
Unique Audio Solutions

# ***Kommander-KA02 I***

User Guide

This page intentionally left blank

### IMPORTANT SAFETY INSTRUCTIONS



**CAUTION**  
RISK OF ELECTRIC SHOCK  
DO NOT OPEN



**ATTENTION:** RISQUE DE CHOC ELECTRIQUE NE PAS OUVRI

**CAUTION:** TO REDUCE THE RISK OF ELECTRIC SHOCK,  
DO NOT REMOVE COVER (OR BACK).  
NO USER-SERVICEABLE PARTS INSIDE.  
REFER SERVICING TO QUALIFIED SERVICE PERSONNEL.



This symbol alerts the user to the presence of recommendations about the product's use and maintenance.



The lighting flash with arrowhead symbol within an equilateral triangle is intended to alert the user to the presence of uninsulated, dangerous voltage within the product enclosure that may be of magnitude to constitute a risk of electrical shock.



The exclamation point within an equilateral triangle is intended to alert the user to the presence of important operating and maintenance (servicing) instructions in this guide.



Operator's manual; operating instructions  
This symbol identifies the operator's manual that relates to the operating instructions and indicates that the operating instructions should be considered when operating the device or control close to where the symbol is placed.



For indoor use only  
This electrical equipment is designed primarily for indoor use.



WEEE  
Please dispose of this product at the end of its operational lifetime by bringing it to your local collection point or recycling center for such equipment.



This device complies with Restriction of Hazardous Substances Directive.



**WARNING**  
Failure to follow these safety instructions could result in fire, shock or other injury or damage to the device or other property.

### General heed and warnings

- Read these instructions.
- Keep these instructions.
- Heed all warnings.
- Follow all instructions.
- Do not use this apparatus near water.
- Clean only with dry cloth.
- Do not block any ventilation openings. Install in accordance with the manufacturer's instructions.
- Do not install near any heat sources such as radiators, heat registers, stoves, or other apparatus (including amplifiers) that produce heat
- Do not defeat the safety purpose of the polarized or grounding plug. A polarized plug has two blades with one wider than the other. A grounding plug has two blades and a third grounding prong. The wide blade or the third prong is provided for your safety. If the provided plug does not fit into your outlet, consult an electrician for replacement of the obsolete outlet.
- Only use attachments/accessories specified by the manufacturer.
- Protect the power cord from being walked on or pinched particularly at the plugs, convenience receptacles, and at the point where they exit from the apparatus.
- Clean the product only with a soft and dry fabric. Never use liquid cleaning products, as this may damage the products cosmetic surfaces.
- Use only with the cart, stand, tripod, bracket, or table specified by the manufacturer, or sold with the apparatus. When a cart is used, use caution when moving the cart/apparatus combination to avoid injury from tip-over.
- Unplug this apparatus during lightning storms or when unused for long periods of time.
- Avoid placing the product in a location under direct sunlight or near any appliance that generates UV (Ultra Violet) light, as this may change the product surface finishing and cause a change in color.
- Refer all servicing to qualified service personnel. Servicing is required when the apparatus has been damaged in any way, such as power-supply cord or plug is damaged, liquid has been spilled or objects have fallen into the apparatus, the apparatus has been exposed to rain or moisture, does not operate normally, or has been dropped.
- CAUTION: These servicing instructions are for use by qualified service personnel only. To reduce the risk of electric shock, do not perform any servicing other than that contained in the operating instructions unless you are qualified to do so.
- WARNING: Only use attachments/accessories specified or provided by the manufacturer (such as the exclusive supply adapter, battery, etc.).



This apparatus is intended for professional use.

Installation and commissioning may only be carried out by qualified and authorized personnel.

# Kommander-KA02 I

## User Guide

- Before turning the power on or off for all devices, set all volume levels to minimum.
- Use only speaker cables for connecting speakers to the speaker terminals. Be sure to observe the amplifier's rated load impedance particularly when connecting speakers in parallel. Connecting an impedance load outside the amplifier's rated range can damage the apparatus.
- K-array cannot be held responsible for damage caused by improper use of the loudspeakers.
- K-array will not shoulder any responsibilities for products modified without prior authorization.

### CE Statement

K-array declares that this device is in compliance with applicable CE standards and regulations. Before putting the device into operation, please observe the respective country-specific regulations!



### FCC Statement

This equipment has been tested and found to comply with the limits for a Class B digital device, pursuant to part 15 of the FCC Rules. These limits are designed to provide reasonable protection against harmful interference in a residential installation. This equipment generates, uses and can radiate radio frequency energy and, if not installed and used in accordance with the instructions, may cause harmful interference to radio communications. However, there is no guarantee that interference will not occur in a particular installation. If this equipment does cause harmful interference to radio or television reception, which can be determined by turning the equipment off and on, the user is encouraged to try to correct the interference by one or more of the following measures:



1. Reorient or relocate the receiving antenna.
2. Increase the separation between the equipment and receiver.
3. Connect the equipment into an outlet on a circuit different from that to which the receiver is connected.
4. Consult the dealer or an experienced radio/TV technician for help.

### FCC Radiation Exposure Statement

This device complies with FCC radiation exposure limits set forth for an uncontrolled environment. This equipment must be installed and operated in accordance with provided instructions and the antenna(s) used for this transmitter must be installed to provide a separation distance of at least 20 cm from all persons.

This device complies with Part 15 of the FCC Rules. Operation is subject to the following two conditions:

1. this device may not cause harmful interference, and
2. this device must accept any interference received, including interference that may cause undesired operation.

**CAUTION!** Any changes or modifications not expressly approved by the party responsible for compliance could void the user's authority to operate the equipment.

### Canadian Statement

This device complies with Industry Canada's licence-exempt RSSs. Operation is subject to the following two conditions:

- this device may not cause interference, and
- this device must accept any interference, including interference that may cause undesired operation of the device.

The device meets the exemption from the routine evaluation limits in section 2.5 of RSS 102 and compliance with RSS-102 RF exposure, users can obtain Canadian information on RF exposure and compliance.

This equipment should be installed and operated with a minimum distance of 20 centimeters between the radiator and your body.

### Trademark Notice

All trademarks are the property of their respective owners.

### Sommario

Unpacking	8	Dashboard	15
Kommander-KA02 I Rear Panel	8	USB Media Player	15
Software	8	Bluetooth Media Player	15
Introduction	9	Webradio Media Player	15
Getting Started	9	DanteReady™ streamer	15
Mounting and cooling	10	Device preset	15
AC MAINS supply	10	Audio Configuration	16
LED chart	10	Output Configuration	16
Status LED	10	MATRIX	17
Input wiring	11	INPATCH	17
Loudspeaker wiring	11	Network	18
SE: Single-Ended Load	11	Wifi	18
PBTL: Parallel Bridge-Tied Load	11	Ethernet	18
K-REMUCTRL Remote	12	Bluetooth	18
Remote Connectivity	13	Advanced	18
Connectivity Reset	13	System Update	18
K-array Connect Mobile App	14	K-framework3	20
Connecting To The Built-In Hot Spot	14	Discovery	21
Embedded Web App	15	Grouping	21
		Mechanical Drawing	22
		Specifications	23

# ***Kommander-KA02 I***

User Guide

This page intentionally left blank

# **Kommander-KA02 I**

## User Guide

Thank you for choosing this K-array product!

To ensure proper operation, please carefully read the owner's manuals and safety instruction before using the products. After reading this manual, be sure to keep it for future reference.

Should you have any questions about your new device please contact K-array customer service at [support@k-array.com](mailto:support@k-array.com) or contact the official K-array distributor in your country.

---

The Kommander-KA02I is a fully featured 4x50W @ 4Ω class-D amplifier with a high-performing DSP. The digital processing multi-channel amplifier is designed for optimized performance in small to medium loudspeaker systems.

The Kommander-KA02I implements the Integrated Electronic Brain (IEB) technology with oskar custom operating system running on quad-core 1.5 GHz internal processor.

The K-array Connect mobile app provides the control dashboards to access all Kommander-KA02I DSP features for system settings, fine tuning and monitoring.

# Kommander-KA02 I

## User Guide

### Unpacking

Each K-array amplifier is built to the highest standard and thoroughly inspected before leaving the factory.

Upon arrival, carefully inspect the shipping carton, then examine and test your new amplifier. If you find any damage, immediately notify the shipping company. Check that the following parts are supplied with the product.

- A. 1x Kommander-KA02I amplifier unit
- B. 2x Output channel flying connectors  
two terminals Euroblock 2,5/ 2-ST-5,08
- C. 1x Output channel flying connector  
four terminals Euroblock 2,5/ 4-ST-5,08
- D. 4x Balanced input flying connectors  
three terminals Euroblock 1,5/ 3-ST-3,81
- E. 1x Power supply with power cord
- F. 1x The quick guide

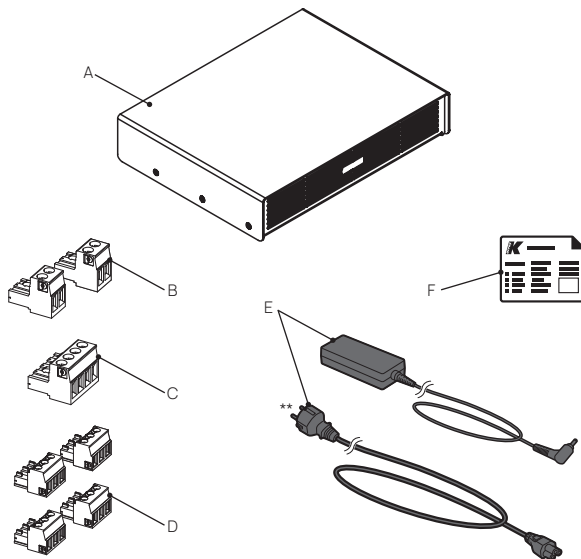

Notes

\*\* The AC mains cord plug may differ from the picture according to local regulation.

### Kommander-KA02I Rear Panel

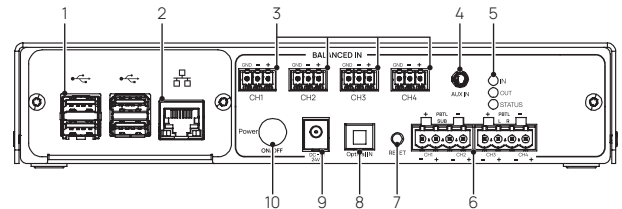

- 1. 4x USB ports
- 2. RJ45 Ethernet port
- 3. 4 channels Euroblock 1,5/ 3-ST-3,81 balanced analog inputs
- 4. 3,5 mm jack unbalanced stereo analog input
- 5. Status LED
- 6. 4 channels Euroblock output terminals: speaker connectors for either 2,5/ 2-ST-5,08 or 2,5/ 4-ST-5,08 flying plugs
- 7. Reset button
- 8. Optical S/P DIF stereo digital input
- 9. DC inlet
- 10. Power switch

### Software

The dedicated K-array Connect app and the K-framework3 software for Mac and PC allow the user to access to the highly configurable output section and the powerful DSP making any Kommander-KA02I amplifier a flexible driving unit.





## Introduction

The Kommander-KA02I is the smallest amplifier unit in the Kommander line with an incredibly compact size of 219 x 46 x 170 mm (8.6 x 1.8 x 6.7 in).

With the backing of 200W, the Kommander-KA02I amplifier unit can be arranged in multiple output configurations such as 4x50W, 2x100W, 2x50W + 1x100W.

The amplifier features four balanced analog inputs and a fiber optical input working up to 192 kHz. It boasts Bluetooth connectivity, mini jack input and USB ports for using MP3, WAV, FLAC, AAC, ecc., files.

Enhanced performance and easy tuning are managed by the Integrated Electronic Brain – IEB – implemented into the amplifier unit. More than a traditional DSP, the built-in micro electronics driven by the integrated operating system osKar features expansive sound processing – input gain, signal routing matrix, delay, full parametric IIR filters (Peaking, Shelving, Hi/Lo pass, Hi/Lo Butterworth) and on-board preset –, offering complete user control over the system performance.

## Getting Started

1. Connect the input and output signal cables according to the configuration you want to achieve.
2. Connect the Kommander-KA02I to its power supply and plug the power cord to the AC mains socket.
3. Use the K-array Connect app to connect your mobile device to the Kommander amplifier unit
4. Set the amplifier Output Configuration\*: the Devices menu will show the device(s) you can manage with the app: press on the image of the unit to configure.



**Carefully check that the factory presets match the actual configuration of passive speakers connected to the amplifier connectors.**

5. Set the signal routing from the input channels to the output channels in the ROUTING tab.
6. Check the signal volume in the VOLUMES tab.
7. Enjoy K-array sound!

\* Azimut systems are factory configured.

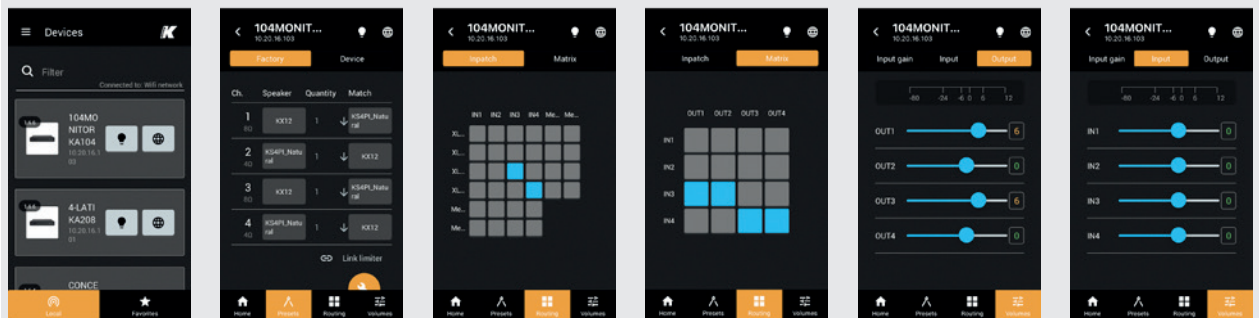

# Kommander-KA02 I

## User Guide

### Mounting and cooling

The Kommander-KA02I amplifier and processing unit can be set stand alone or installed into rack cabinets with the K-RACK24 rack-mounting hardware accessory.

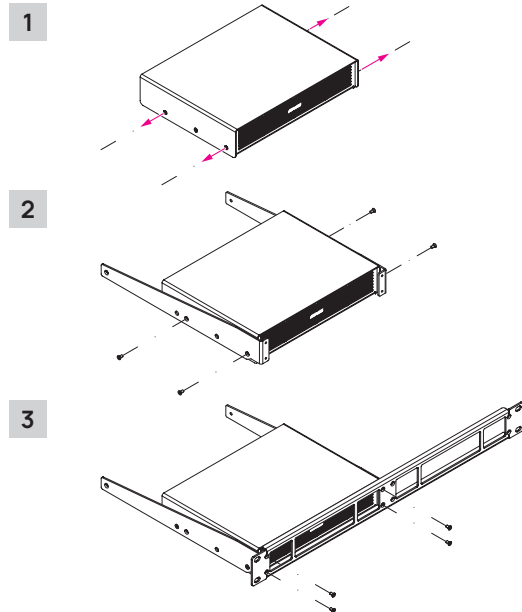

1. Unscrew the first and the third lateral screw on each side of the Kommander-KA02I chassis.
2. Use the screws included in the K-RACK24 package to fix the lateral brackets to the Kommander-KA02I chassis.
3. Fix the brackets to the front panel.

The K-RACK24 rack-mounting accessory suites two Kommander-KA02I units in 1U.

Install the amplifier in a well-ventilated location: the ventilation openings must not be impeded by any item.

Fresh air enter the amplifier from the bottom plate, warm air is expelled from the front panel.

### AC MAINS supply

The Kommander-KA02I amplifier unit is provided with a dedicated 24 V<sub>DC</sub> LPS power supply, suiting any nominal input operating voltage in the range 100-240 VAC - 50/60Hz.



It is strongly recommended using certified 24 V<sub>DC</sub>, 4.0 A LPS power supply only

- A. Connect the power adapter to the power cord;
- B. Connect the power plug to a mains socket outlet;
- C. Connect the power adapter to the DC inlet on the rear panel of the Kommander-KA02I amplifier unit.
- D. Power up the unit by pressing the POWER button on the rear panel.

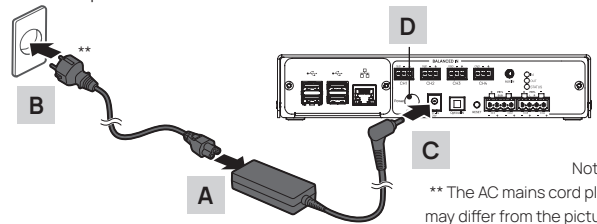





Notes

\*\* The AC mains cord plug may differ from the picture according to local regulation.

### LED chart

In the rear panel, the input signal monitor LED and the output signal monitor LED blink according to the presence of audio signal at any input or output channel respectively. The input and output signal monitor LEDs light on orange when the DSP is limiting the signal level.

### Status LED

Color	Mode	Description
	orange solid	DSP software is loading
	green solid	System ready
	blue solid	User command: system identification
	purple flashing	Network parameters reset

### Input wiring

Audio signals can be fed to the Kommander-KA02I amplifier unit using the input connectors on the rear panel.

The following input ports are available:

- BALANCED IN: 4x Euroblock 1,5/ 3-ST-3,81 ports for analogue mono balanced and unbalanced signals;
- AUXILIARY IN: 1x 3,5 mm minijack for analogue stereo unbalanced signals
- DIGITAL IN: 1x Toslink optical connector accepting SP/DIF stereo digital signals up to 192 KHz sample frequency.

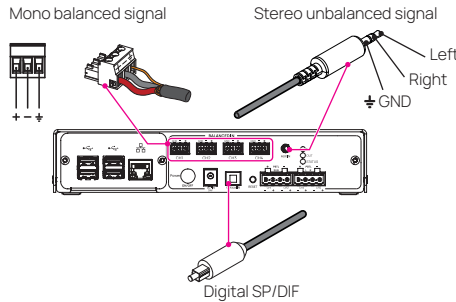

 The auxiliary input is paralleled to mono input CH3 and CH4

In order to route the input signals to the proper output connectors, the built in web app provides a customizable INPATCH routing table



### Loudspeaker wiring

A minimum set of Euroblock flying connectors is provided in the package for connecting the loudspeakers to the amplifier unit.

The actual wiring depends on the loudspeaker configuration.

The following table shows the maximum power delivered at the minimum load impedance by each Kommander-KA02I output channel, in three different output configurations.

Configurations	Output power			
	CH1	CH2	CH3	CH4
4x SE outputs	SE 50 W @ 4 Ω	SE 50 W @ 4 Ω	SE 50 W @ 4 Ω	SE 50 W @ 4 Ω
2x SE outputs 1x PBTl output	PBTl 100 W @ 2 Ω		SE 50 W @ 4 Ω	SE 50 W @ 4 Ω
2x PBTl outputs	PBTl 100 W @ 2 Ω		PBTl 100 W @ 2 Ω	

#### SE: Single-Ended Load

The simplest and most common method to connect a loudspeaker to the amplifier channel terminals: one channel terminal feeds a varying voltage that represents the signal, while the other is connected to ground.

#### PBTl: Parallel Bridge-Tied Load

The power amplifier modifies its internal routing path and power delivery in order to double both the output voltage and the output current, hence quadruple the output power.

The loudspeaker is connected between two amplifier channels in order to double the voltage. Each amplifier channel is loaded with half loudspeaker impedance.

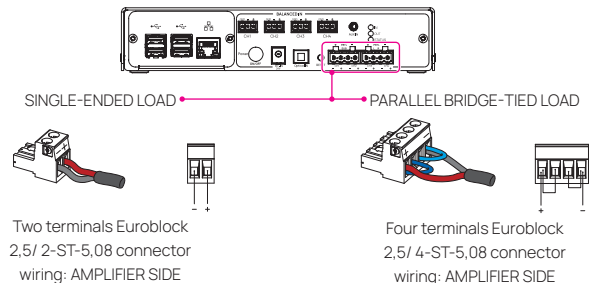

# Kommander-KA02 I

## User Guide



Use only high quality speaker cables.  
Wire gauges must comply with the loudspeaker nominal impedance according to the cable run.

Leveraging on the K-array loudspeaker impedance, the Kommander-KA02I output channels can be connected to multiple loudspeakers in parallel.

The following table shows some examples of the maximum number of loudspeakers that can be connected to the Kommander-KA02I output channels.

Loudspeaker Name	Z	Max number of loudspeaker units per channel			
		CH1	CH2	CH3	CH4
Lyzard-KZ1	16 Ω	4x (SE)	4x (SE)	4x (SE)	4x (SE)
Lyzard-KZ14	16 Ω	4x (SE)	4x (SE)	4x (SE)	4x (SE)
Vyper-KV25	8 Ω	2x (SE)	2x (SE)	2x (SE)	2x (SE)
Tornado-KT2	8 Ω	2x (SE)	2x (SE)	2x (SE)	2x (SE)
Truffie-KTR24	4 Ω	2x (PBTL) or 1x (SE)		2x (PBTL) or 1x (SE)	
Truffie-KTR25	4 Ω	2x (PBTL) or 1x (SE)		2x (PBTL) or 1x (SE)	
Truffie-KTR26	2 Ω	1x (PBTL)		1x (PBTL)	
Rumble-KU44-2	2 Ω	1x (PBTL)		1x (PBTL)	



The proper output configuration presets shall be set in the K-array Connect Mobile App, K-framework3 or embedded web app

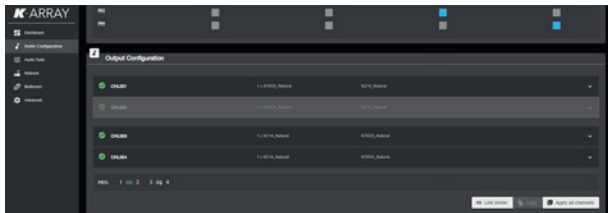

## K-REMUCTRL Remote

K-REMUCTRL is the optional wireless remote dedicated to control the Kommander-KA02I amplifier unit\*.

In order to use the K-REMUCTRL with the Kommander-KA02I amplifier:

1. ensure the system software is up to date;
2. pull out the dongle from the K-REMUCTRL remote package;
3. plug the dongle to any free USB port on the amplifier rear panel;
4. switch on both the amplifier and the K-REMUCTRL remote.

The K-REMUCTRL remote includes a high-efficiency rechargeable battery with a switch that can extend the battery life when powered off.

When the battery discharges to approximately 10% remaining life, the Status LED begins flashing: connect the remote's charge port to a standard USB port to recharge the internal battery; use the provided cable.

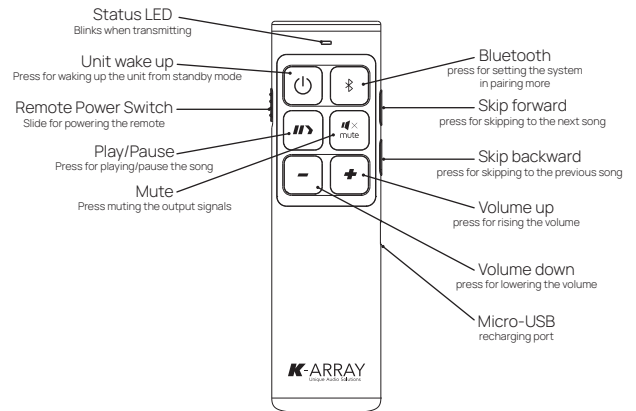

The K-REMUCTRL remote works on the media player volume only: future updates of the osKar system will make it available for the input volumes.

### Note

\* The K-REMUCTRL is included in the Azimut package

## Remote Connectivity

The Kommander-KA amplifier unit features a built-in hot spot establishing a local Wi-Fi network dedicated to remote control the amplifier with mobile devices.

The default local Wi-Fi SSID and unit IP address are printed on a label located on the rear plate of the unit; a QR code for easing the connectivity is printed as well.

The RJ45 Ethernet port on the rear panel allows to connect the unit to a local area network (LAN). Since every host on a network must be identified by a unique IP address, the simplest local network usually implement a router/switch with a DHCP server managing the addresses allocation: by default the Kommander-KA unit is set to obtain a local IP address from the DHCP server.

In case a DHCP server is not present on the LAN, the unit goes in AutoIP mode: in few seconds the amplifier automatically self-assign an IP address in the range 169.254.0.0/16.

A static IP address can be assigned to the amplifier unit using the amplifier's embedded web app (Network menu).

## Connectivity Reset

With the unit switched on, keep pressed the RESET button on the rear panel for 10 to 15 seconds in order to:

- Revert the wired IP addressing to DHCP;
- Activate the built-in Wi-Fi and reset the wireless parameters to the default SSID name and password

The status LED turns purple while the RESET button is pressed.

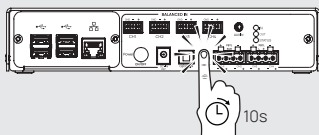

The Kommander-KA02I amplifiers can be controlled remotely by a mobile device or desktop PC/MAC.

### K-array Connect mobile app

K-array Connect is the mobile app that allows to direct manage and control a Kommander-KA amplifier with a mobile device (smartphone or tablet) wireless.

Download the K-array Connect mobile APP from the dedicated store of your mobile device.



### Embedded web app

The integrated operating system osKar features a complete web user interface accessible over the network: connect to the Kommander-KA02I on a local network or wireless via its built-in hot spot and access the web app with a web browser (Google Chrome recommended).

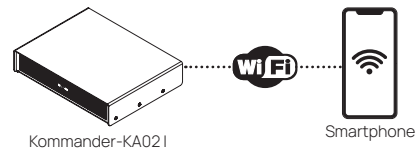

### K-framework3

The K-array K-framework3 is the managing and control software dedicated to professionals and operators looking for a powerful tool for designing and managing a large number of units in demanding applications. Download the K-framework3 software from K-array website.

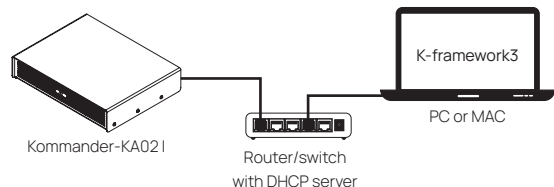
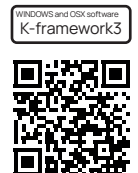

# Kommander-KA02 I

## User Guide

### K-array Connect Mobile App

The K-array Connect mobile app allows to access the Kommander-KA02I amplifier unit wireless, leveraging on the local Wi-Fi established by the built-in hot spot.

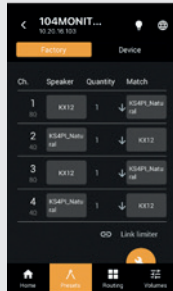
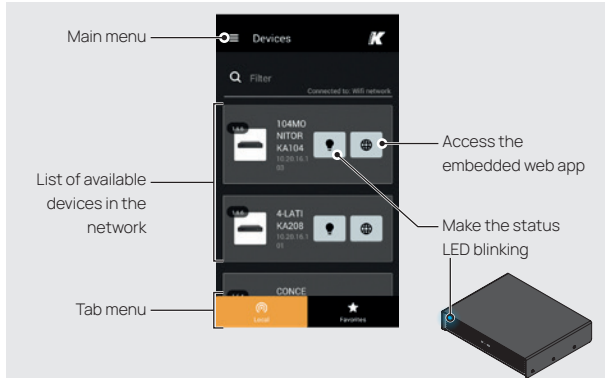

**Preset menu**  
Load the loudspeaker factory presets on the output channels and manage the device configuration presets.

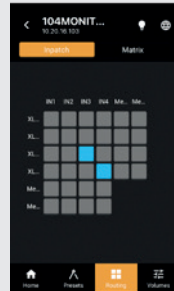

**Routing menu**  
**INPATCH**  
Patch the input signals to the DSP inputs.

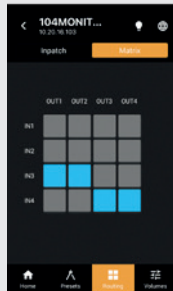

**Preset menu**  
**MATRIX**  
Set the signal routing from the DSP to the output connectors.

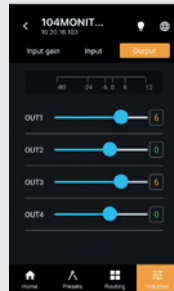

**Volumes menu**  
Manage the the input and output volumes.

### Connecting To The Built-In Hot Spot

1. Ensure the Wi-Fi of the mobile device is on.
2. Launch the K-array Connect app.
3. If the list of available devices is empty touch the SCAN QR CODE button and use the mobile device camera to frame the QR code in the bottom panel of the Kommander-KA unit: this provides the mobile device to connect to the amplifier's hot spot.
4. Click on the image of the Kommander-KA unit to manage the amplifier with the K-array Connect app or click on the button with the globe in order to launch the embedded web app.



In case you need to connect manually connect to the amplifier's hot spot, the default password is the device serial number, e.g. K142AN0006 (case sensitive).

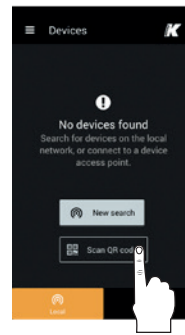

Scroll down to update the list of devices or touch the Scan QR code button to activate the camera in order to connect the unit

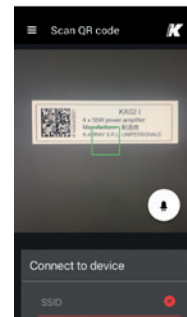

The K-array active unit has a label with the QR code for connecting the local Wi-Fi: target the code to establish the wireless connection



Connected and discovered!

### Embedded Web App

The embedded web app provides direct access to the operating parameters of the amplifier unit.

The web app is accessible via a web browser (Google Chrome recommended) over a wired or wireless connection to the amplifier unit.

The K-array Connect Mobile App and the K-framework3 software interfaces include a shortcut for opening the web app, once the connection to the amplifier unit is established.

If the amplifier unit is connected to a LAN and its IP address is set and known, it is possible to access its embedded web app typing its IP address in the address bar of the web browser.

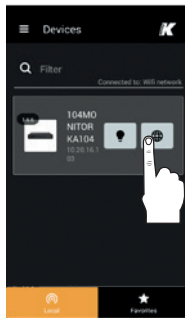

### Dashboard

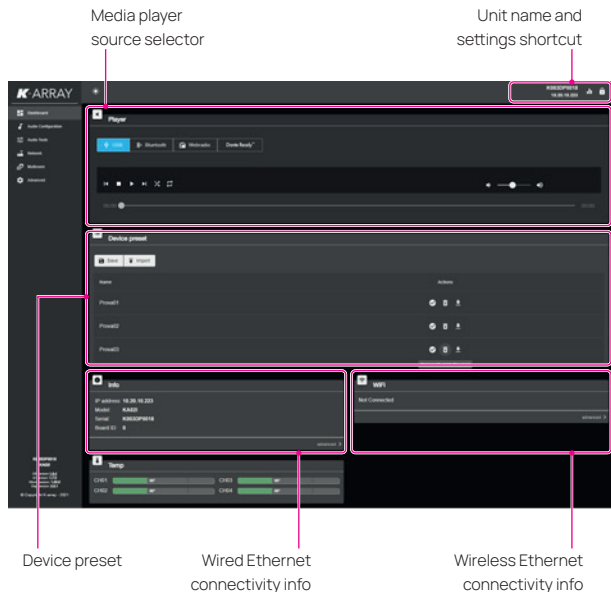

The default menu provides access to the media player and the amplifier unit setup parameters.

### USB Media Player

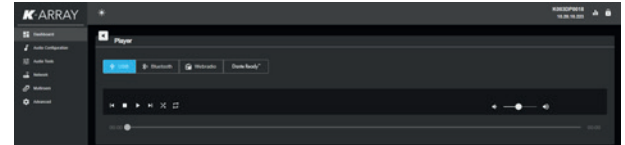

### Bluetooth Media Player

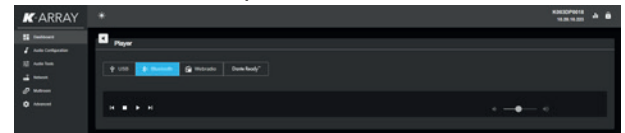

### Webradio Media Player

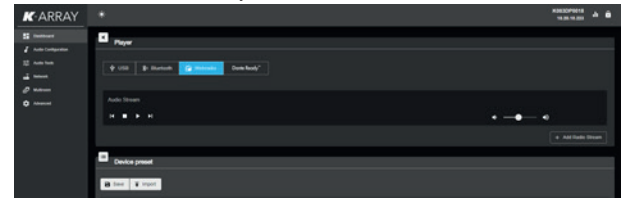

### DanteReady™ streamer

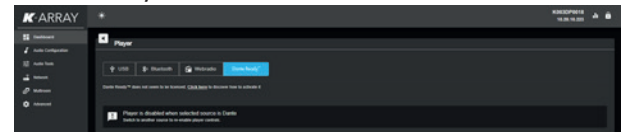

The units born with no active Dante channels and can be upgraded to 2 IN x 2 OUT Dante channels (Ships with 0x0 / Upgradeable to 2x2).

Customers can make channel purchases directly within Dante Controller using Audinate's payment system.

### Device preset

This tab contains the slot where to manage (save, import, export, delete) the unit configuration.

# Kommander-KA02 I

## User Guide

### Audio Configuration

Use this menu to access the input/output signal routing and output configuration

### Output Configuration

The Output Configuration is where the K-array loudspeaker factory presets can be loaded on the output channels. By default, all Kommander-KA units born with all the amplifier's output connections muted: in order to activate the output channels the output configuration shall be set. Care must be taken matching the loudspeaker presents with the actual loudspeaker configuration\*.

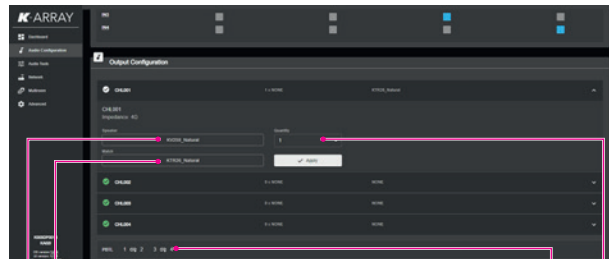

#### Loudspeaker Preset

Select the factory loudspeaker preset matching the actual loudspeaker model and version connected to this output channel

#### Matched Loudspeaker

Select the factory loudspeaker preset matching the subwoofer or mid/high loudspeaker used in the actual configuration: this parameter sets the frequency crossover point.

#### Toggle PBTL

Set the loading configuration of the selected output channel pair

#### Loudspeakers in parallel

Select the number of loudspeakers connected in parallel to this output channel

1. Navigate the menu and go to Audio Configuration.
2. Go to the Output Configuration section.
3. Select the output channel to be configured.
4. Select the speaker factory preset corresponding to the loudspeaker model and version actually connected to the amplifier output connector.
5. If needed, set the number of loudspeakers that are connected in parallel to the amplifier output connector.

6. Select the matching loudspeaker, i.e. the subwoofer used in the actual loudspeaker configuration (eg. the Truffle-KTR26 matching the Vyper-KV25II) or the high/mid loudspeaker when configuring a subwoofer output channel (eg. the Lizard-KZ14I matching the Truffle-KTR25).

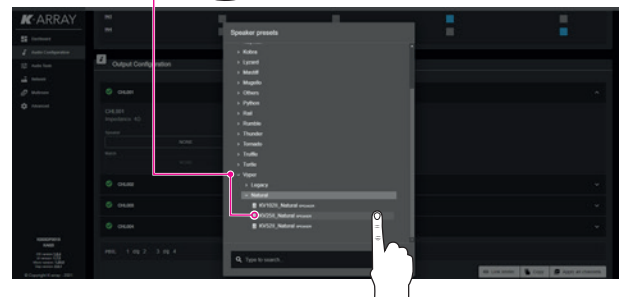
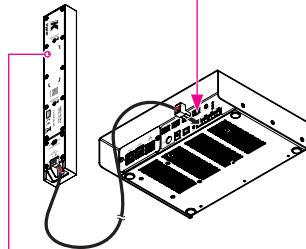
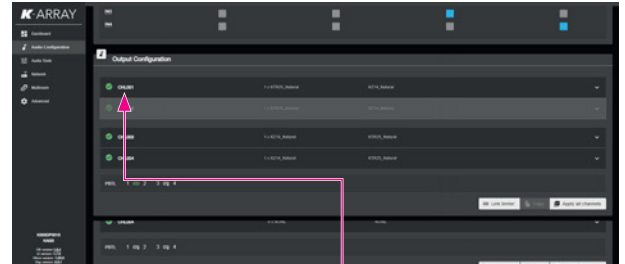

Ensure to set the proper loudspeaker factory preset corresponding to the actual loudspeaker connected to the amplifier output channel

#### Note

\*The output configuration of the Kommander-KA02I included in an Azimut system bundle is factory pre-configured.



7. Apply the output channel configuration.
8. If needed set the proper pairing channels in PBTLM mode.
9. Go to the Routing section and set the proper signal routing.

## MATRIX

The matrix allows to set the signal routing path between the four amplifier's input channels and the four amplifier's output connectors.

Blue boxes at the cross intersection between rows and columns state an open path between sources (raw) and destinations (columns).

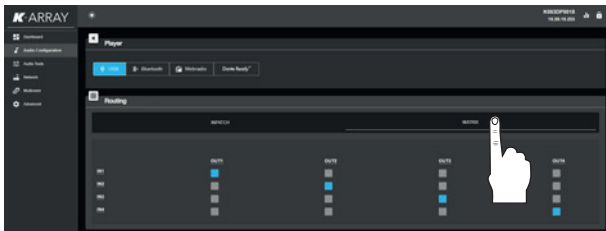

## INPATCH

The input patch tab allows to address the input connections and the input streamer (media player) to the four amplifier's input channels.

The signal managed by the media player can be routed to the amplifiers' input channels via the Media-1 OUT and Media-2 OUT.

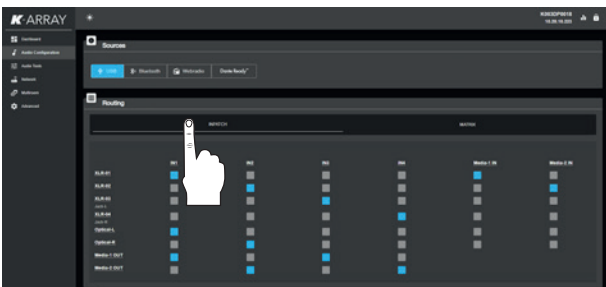

# Kommander-KA02 I

## User Guide

### Network

This menu section allows the user to monitor and set the network parameters both wired, wireless and Bluetooth.

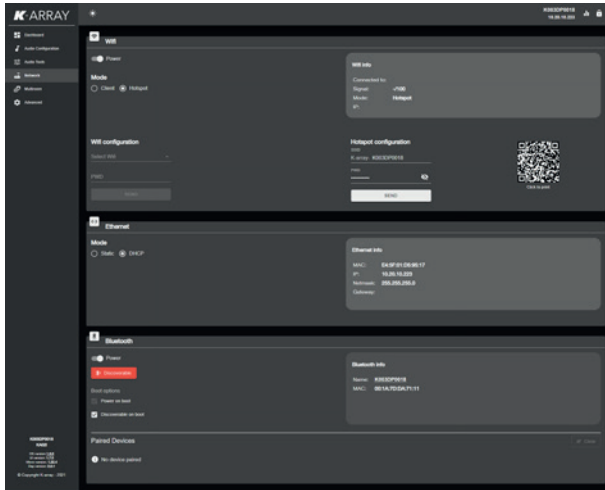

#### WiFi

The WiFi can be configured to connect the unit to a wireless LAN as a CLIENT or, alternatively, to create an independent local wireless network behaving as HOT SPOT.

By default the WiFi is set as HOT SPOT allowing any mobile device to connect to the unit.

By default, the SSID of the HOT SPOT is composed by the word "K-array-" followed by the serial number of the unit; the default password is the unit's serial number. The SSID and the password of the HOT SPOT can be modified manually: the QR Code will change accordingly.

When set as CLIENT, enter the data of the WiFi LAN in order to connect the unit to that network.

The power switch allows to toggle on and off the WiFi.

#### Ethernet

Set the IP addressing static or DHCP.

### Advanced

This menu provides access to the system informations, like the device name and ID and the system update tool.

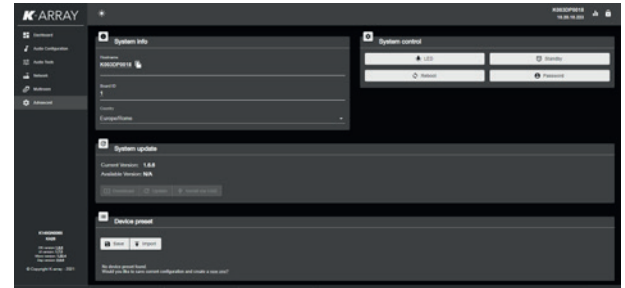

### System Update

In order to update the internal DSP software and osKar operating system two methods are available: via an Internet connection or USB key.

#### Update via Internet

1. Connect the Kommander-KA amplifier to Internet – possibly via a wired connection.
2. The Download button turns active when a new software version is available on K-array server: when active, press on the Download button to start downloading the software from the Internet. This step doesn't install the software: the installation shall be actiated manually.

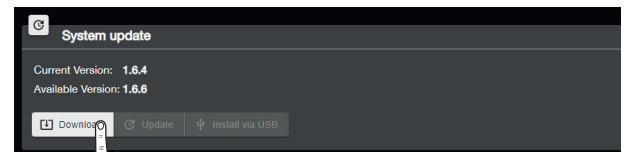

3. The Update button activates when the software is completely downloaded: when active, press on the Update button to start updating the Kommander-KA amplifier.

# Kommander-KA02 I

User Guide

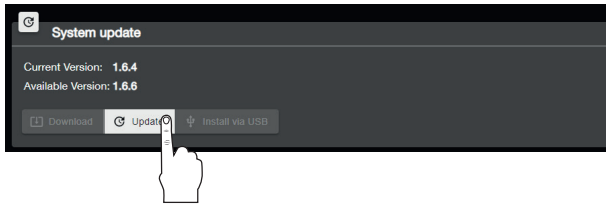

The update procedure lasts in about 15 minutes: after updating the Kommander-KA02I amplifier unit reboots.

## Update via USB

- Make a folder named **update** (case sensitive) on the root of a USB key or drive.

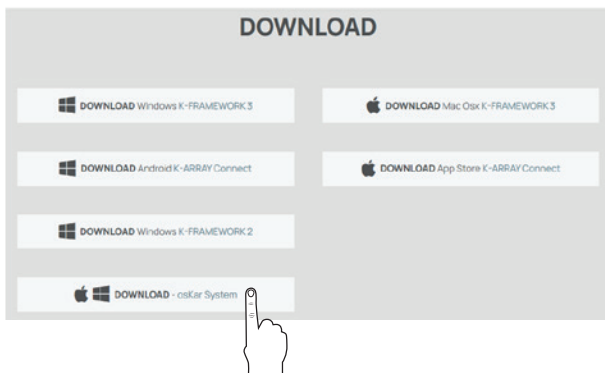
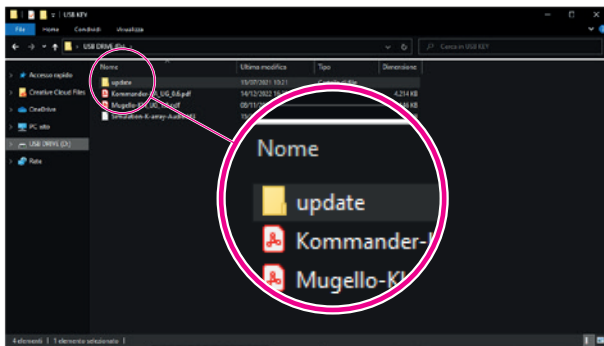

- Open the K-array website on the Internet browser on your PC or Mac.
- Navigate the Products→Software menu and scroll down to the Download section of the Software webpage.
- Download the osKar System (ensure to be registered to the website in order to proceed with the download) and save the update file with extension **.mender** into the **update** folder on the USB drive.
- Plug the USB drive to a free USB port on the amplifier rear panel.

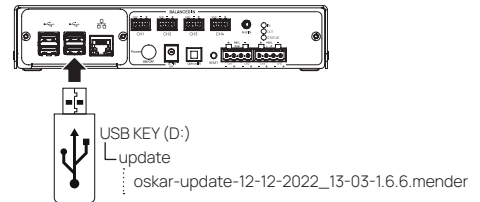

- If not already operating, switch on the Kommander-KA amplifier.
- Connect your mobile device to the Kommander-KA amplifier and access the embedded web app.
- Navigate the user interface to the Advanced menu: the Install via USB button activates when the USB drive contains the .mender file in the proper folder.



- Press on the Install via USB button to start updating the Kommander-KA unit.

The update procedure lasts in about 15 minutes: after updating the Kommander-KA02I amplifier unit reboots.

# Kommander-KA02 I

## User Guide

### K-framework3

The Kommander-KA021 unit can be remotely controlled with the dedicated K-framework3 software available for PC and MAC on K-array website.

The K-framework3 is the managing and control software dedicated to professionals and operators looking for a powerful tool for designing and managing a large number of units in demanding applications.

WINDOWS and OSX software  
K-framework3

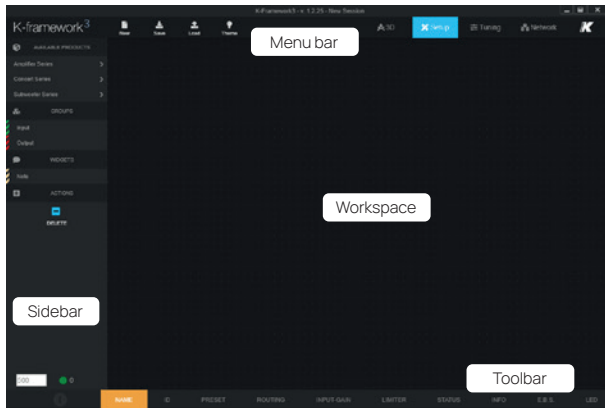

The K-framework3 operates in three modes:

- 3D – Design a loudspeaker system for your venue in a full 3D environment and make free field acoustic simulations;
- SETUP – import from the 3D design the active components into the workspace or build from scratch a PA system composed of active loudspeakers and amplifiers; use the input and output groups to allow full control of the system;
- TUNING – Manage and control the loudspeaker system in real time: optimize the performance of the loudspeaker system during the tuning session and control its behavior in live events.

The K-framework3 can work either off-line with virtual devices or on-line with real active loudspeakers and amplifiers connected over the same Ethernet network.

The K-framework3 allows you to start designing the PA system off-line and sync the virtual devices to the real ones on site, when the devices are available, or import from scratch in the workspace the real active loudspeakers and amplifiers available on the network. In both cases, in order to discover and sync the active devices, both the PC or Mac running the K-framework3 and the real units shall be properly connected to the same Local Area Network – LAN – with star topology.

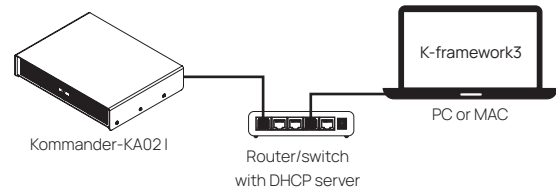

The network shall comprise:

- single PC or MAC, running the K-framework3 software with network interface 100Mbps (or higher);
- router with DHCP server 100Mbps (or higher);
- Ethernet switch 100Mbps (or higher);
- Cat5 (or higher) Ethernet cables.

A DHCP server is highly recommended even if the device units implement the zeroconf network technologies: if a DHCP service is not available, every device will self assign an IP address in the range 169.254.0.0/16 (auto-IP).

### Discovery

1. Ensure that any amplifier units and the PC/Mac running the K-framework3 are properly connected to the same network.
2. Power up the Kommander-KA units.
3. Launch the K-framework3.
4. Open the Network window and launch the discovery:



- If the K-framework3 finds two or more devices with the wrong ID, a dialog window appears where unique IDs can be assigned to the units.



5. Once discovered, the real units are shown in the left columns, following the order of their ID number; if the workspace contains virtual devices of the same type you can eventually modify the IDs in order to match the units and allows the synchronization. The synchronization can be in either directions: Workspace-to-Real or Real-to-Workspace. Select the sync direction and synchronize all or the single units separately

### Grouping

The working paradigm in the K-framework3 is to group the input and output channels of the amplifiers on the workspace and adjust the system performance within the groups.

Groups can be created working both off-line and on-line and are retained by the real Kommander-KA units even once unplugged: if a real device belongs to a group, the group is re-created on the workspace during the synchronization process.

An active loudspeaker or amplifier might belong to multiple groups sharing its features (eq filters, time delay, volume, etc).



The K-framework3 synchronization process reset to default the EQ, delay and volume parameters edited with the K-array Control mobile app and the embedded Web app.

- A. In Setup mode, set the Kommander-KA local parameters (presets, routing, input gains, limiters, etc).

- B. Add INPUT and OUTPUT groups as needed.

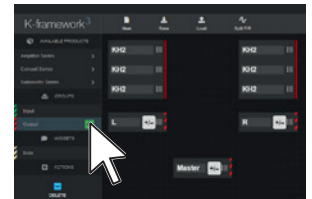

- C. Assign the amplifiers units' channels to the groups.

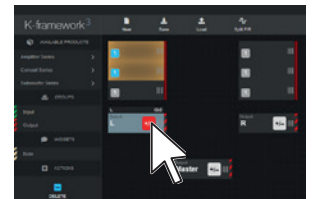

- D. Switch to Tuning mode.
- E. Align the system using the tools available on the groups (eq, delay, polarity, etc).



# Kommander-KA02 I

User Guide

## Mechanical Drawing

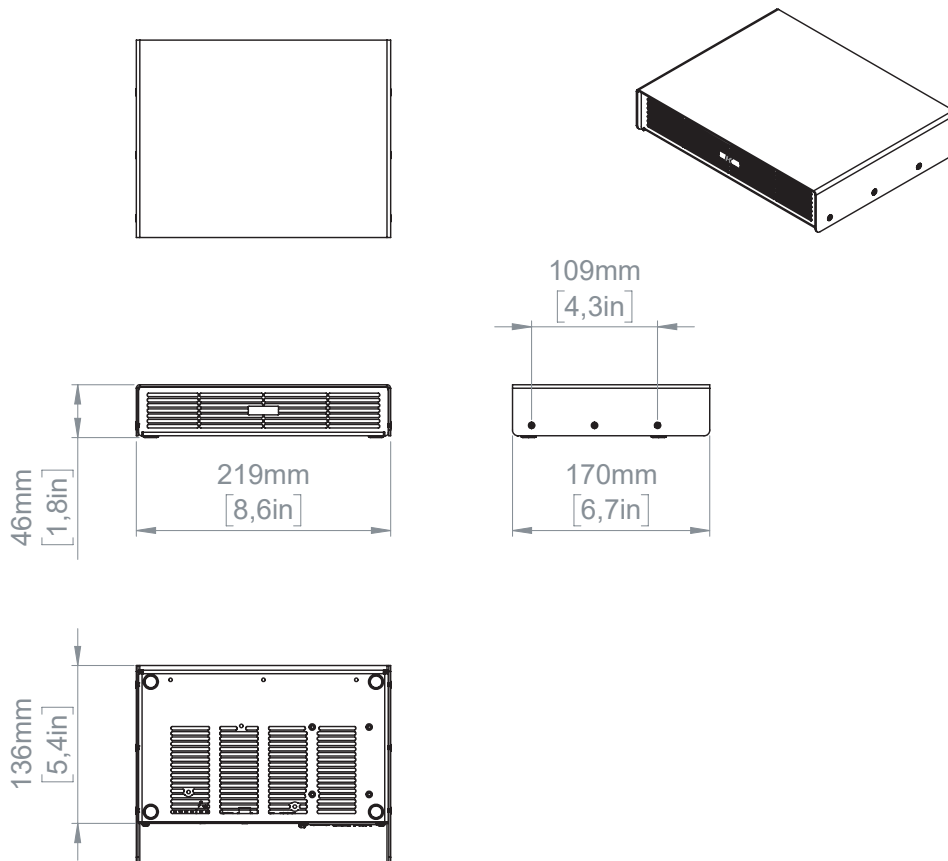

## Specifications

General	
Type	4ch switching mode, Class D Amplifier
Output Power 1	4x 50 W @ 4 $\Omega$
Impedance	minimum 4 $\Omega$ (2 $\Omega$ PBTL)
Frequency Response	20 Hz – 20 kHz ( $\pm$ 1 dB)
Connectors	Input: 4x BAL input: Euroblock 1.5/ 3-ST-3.81, 3.5 mm jack unBAL analog stereo AUX input, TOSLINK optical input,  Output: 4x Speaker output over 2x Euroblock 2.5/ 4-G-5,08  Digital: 4x USB-A 2.0, 1x RJ45 Ethernet, Bluetooth 4.1 Low Energy, Wi-Fi IEEE 802.11 b/g/n
Built-in DSP	Grouping, Input EQ, Output EQ, Signal Routing, Level adjustment, Dynamic Limiters, Delay
Remote control	Wi-Fi dedicated K-array Connect mobile app Ethernet wired K-framework3 multiplatform design and tuning software
MAINS Operating Range	Dedicated AC/DC power adapter 100-240V ~ AC, 50-60 Hz input / 24 V, 4 A DC output
Power Consumption	20 W @ 4 $\Omega$ load, Pink noise, 1/8 rated power
Protections	Over Temp. (Power Limiting – Thermal Shutdown), Short Circuit/Overload Output Protection, Power Limiting, Clip Limiter/Permanent Signal Limiter, High Frequency Protection

<sup>1</sup> CTA-2006 (CEA-2006) Amplifier Power Standard, single channel driven.

Handling & Finishes	
IP Rating	IP20
Dimensions (WxHxD)	219 x 46 x 170 mm (8.6 x 1.8 x 6.7 in)
Weight	0.7 kg (1.5 lb)
Material	Aluminum



Designed and Made in Italy

K-ARRAY surl

Via P. Romagnoli 17 | 50038 Scarperia e San Piero - Firenze - Italy

ph +39 055 84 87 222 | [info@k-array.com](mailto:info@k-array.com)

[www.k-array.com](http://www.k-array.com)